

INSTALLATION GUIDE

LIMNI WALL FACED TOILET SUITE



IMPORTANT

- 1 Inspect the components before installation to ensure there are no visible defects. If a defect is found, do not install the toilet suite and contact the supplier immediately. Claims for defects will not be accepted after the product has been installed.
- 2 This toilet suite is suitable for a variety of set-ups:
 Cistern — accommodates either Back Entry Inlet connection or Bottom Entry Inlet connection (left or right stop valve).
 Pan — universal trap — accommodates S-trap installation or P-trap installation (using appropriate connector; not supplied).
- 3 The toilet suite must be installed by a licensed plumber. Failure to do so may void the warranty.
- 4 Installation must be in accordance with AS/NZS3500.

CISTERN PACKAGE CONTENTS

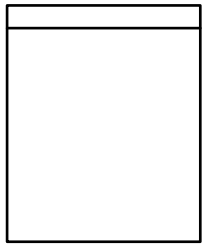

1 x ceramic cistern lid
1 x ceramic cistern base
 Cistern is supplied with flush valve and dual purpose inlet valve already installed.



2 x bolts w seals
 For attaching cistern to pan.



2 x plugs
 Plugs can be used to plug holes in sides of pan if required.



1 x rubber seal
 For sealing outlet at base of cistern.

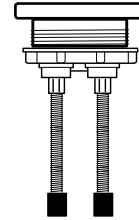

1 x flush button
 Half flush left, full flush right.

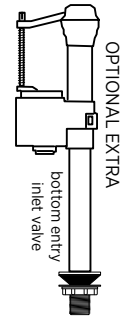

Note: The cistern can be adapted for bottom entry plumbing. The bottom entry inlet valve shown above is an optional extra.

PAN PACKAGE CONTENTS

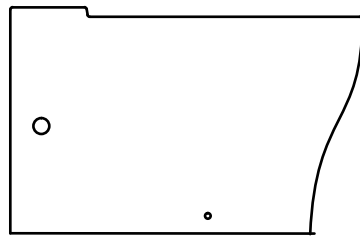

1 x ceramic pan

Threaded section can be trimmed to required size.

Large end of pan connector can be trimmed to suit setout.

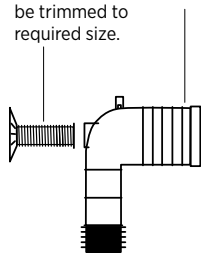

1 x pan connector
 For connecting pan to floor outlet pipe/S-trap.

1 x threaded section (with flange plate)
 Flange attaches to wall; threaded section links to pan connector.

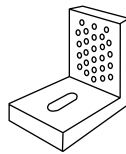

2 x concealed fixing brackets
 Optional — can be used to connect pan to floor.

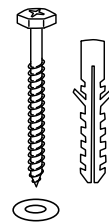

2 x floor bolts (+ white plugs)
2 x washers
 Optional fixing #2 — used with fixing brackets to secure pan to floor. Bolt is inserted through bracket base hole.



2 x caps (chrome plated)
2 x screws
2 x pan plugs (white)
 Optional fixing #2 — used to secure pan to concealed fixing bracket. Plastic plug is placed into hole in side of pan exterior, screw is rebated into plug and then screws into a hole in upright section of bracket. Chrome cap is used to cover plastic plug.

SEIMA

bathroom | kitchen | laundry

seima.com.au

Please note

- Installation shall be in accordance with AS/NZS3500.
- All measurements are in millimetres. Height dimensions are to base of pan. Make allowance for bedding.
- Bedding: Fix pan to floor using a sand cement mixture of 3:1 to a depth of 60mm. Do not use lime or fast-drying cement.
- Bracket fixing: The pan should be bedded with an acetic cured silicone sealant and fixed with the brackets supplied.
- Dimensions are nominal and subject to normal ceramic manufacturing variations.
- Specifications may vary without notice as part of our continuous improvement practices.
- Clean with a damp cloth. Do not use abrasive cleaners, liquids or pastes.

© Seima

limni-wf-in | v 2.0 | page 1 of 4

LIMNI WALL FACED TOILET SUITE

1 S-TRAP PROCEDURE — SECURING THE PAN CONNECTOR IN PLACE

Determine the centre of the **pan** and mark the centre line on the floor and wall.

Work out the setout required. The recommended setout is 150mm (setout range is 90-190mm).

You may need to trim the large end of the plastic **pan connector** to fit the required setout. To trim, first remove the plastic ring and rubber seal, then cut pipe to size. Refit rubber seal and plastic ring securely, ensuring a good fit.

Position the pan connector into the floor outlet pipe (S-trap). The height measurement from the floor to the centre of the pan connector is 185mm.

Slot the **threaded section (with flange plate)** onto the pan connector, ensuring that the flange plate is touching the wall. You may need to trim the threaded section so that it fits properly.

Mark and drill the flange plate holes and secure the plate to the wall with fixing screws. The pan connector is now installed.

2 POSITIONING THE PAN

Use the centre line marked on the wall and floor to position the **pan** (see Step 1.1). Push the pan into the installed plastic pan connector. It is recommended that wedges are used to support the foot of the pan during positioning.

3 CISTERN — COMES SET UP FOR BACK ENTRY INLET PLUMBING

Diagram A shows the cistern as supplied, with the inlet valve and flush valve already installed. The flexible hose is ready for Back Entry inlet plumbing (see Diagram B).

For Bottom Entry Inlet plumbing, refer to Step 5 and Diagrams C and D.

DIAGRAM A

Cistern setup as supplied. The end of the flexible hose is loose, ready to be attached to the Back Entry inlet nozzle (see Diagram B).

NOTE: FLEXIBLE HOSE NOT SUPPLIED.

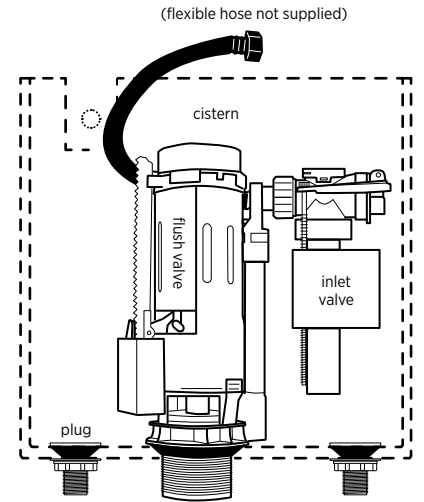

All measurements are in millimetres.
 Height dimensions are to base of pan.
 Make allowance for bedding.
 This toilet suite can be set up as either Bottom Entry Inlet or Back Entry Inlet.

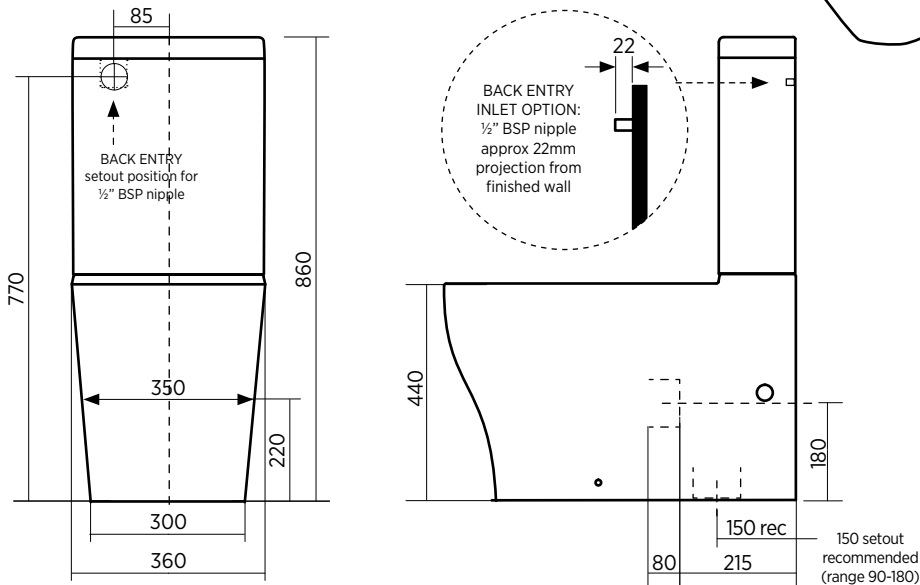
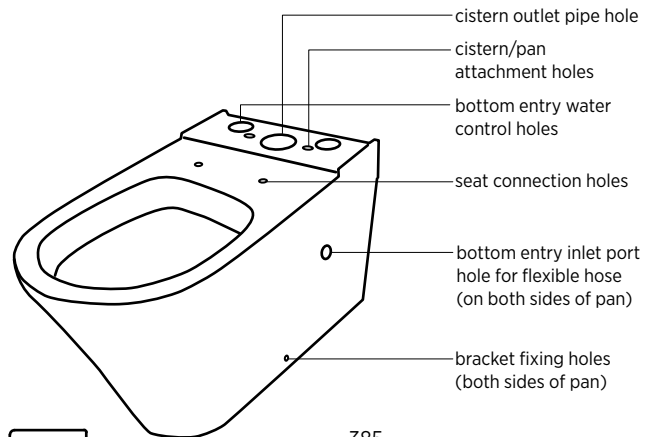

4 BACK ENTRY INSTALLATION

Connect the **flexible hose** to the ½" BSP nipple in the wall outlet. Run the flexible hose behind the flush valve, ensuring that the hose does not obstruct the operation of the flush valve.

DIAGRAM B

For Back Entry Inlet, attach the loose end of the flexible hose to the ½" BSP nipple water inlet in wall.

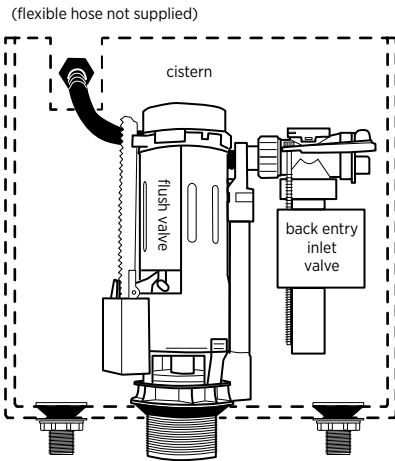

5 CISTERN SET-UP CAN BE ADAPTED FOR BOTTOM ENTRY INLET PLUMBING

First remove two items: the back entry inlet valve and the plug in the base of the cistern. Next, install the bottom entry inlet valve with plug in the hole in the cistern base.

DIAGRAM C

The cistern setup after the back entry inlet valve and base plug have been removed.

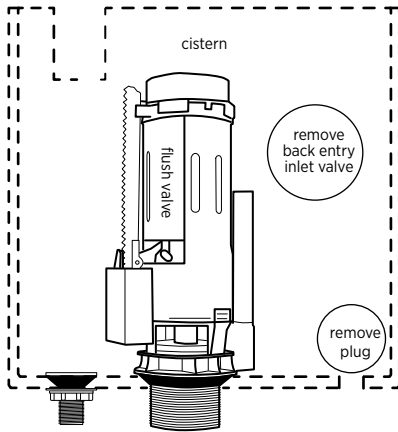
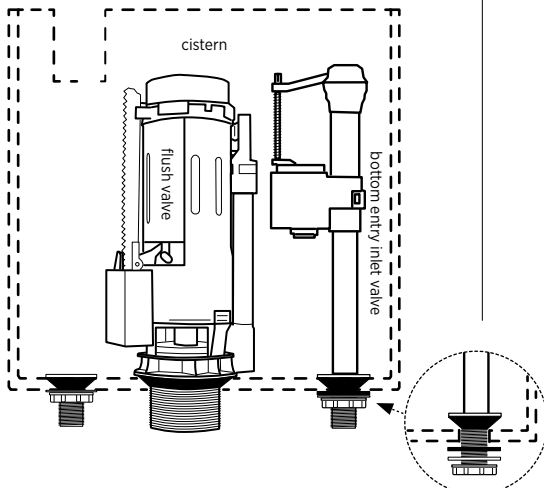

DIAGRAM D

Next, install the bottom entry inlet valve with plug into the hole in the cistern base. Place the conical rubber seal inside the cistern. Outside the cistern thread on the flat rubber seal, white plastic disc and white plastic wing nut in that sequence.



6 SECURING THE PAN ON THE FLOOR

Cement fixing (optional fixing #1)

If using cement bedding, level the pan while the cement mixture is workable. Fix pan to floor using a sand cement mixture of 3:1 to a depth of 60mm. Do not use lime or fast-drying cement.

Important: Allow at least 24 hours for the cement mixture to set before using the toilet.

Bracket fixing (optional fixing #2)

Bed the pan with acetic cured silicone sealant, ensuring that the pan is level. Then position the **concealed fixing brackets** in line with the bracket fixing holes. Screw the **floor bolts** in place through the base of the brackets. Then secure the pan to the brackets using the plastic **pan plugs** and rebated **screws**. The chrome **caps** can be used to cover the plugs on each side of the pan.

Important: Do not over-tighten the bolts or screws as this may cause the ceramic to crack and break.

7 FIXING THE CISTERN TO THE PAN

(Note: The cistern fixes directly onto the pan and does not require wall fixing.)

First check the alignment of the cistern and pan attachment holes — place the **cistern** onto the pan and ensure that the holes align. The back of the cistern and pan should line up so that the assembled toilet suite will align with the wall. Now remove the cistern.

Place the **rubber seal** onto the plastic pipe outlet at the base of the cistern and ensure it is securely attached. Locate the cistern outlet (with rubber seal) onto the pan, ensuring a good fit.

If using Bottom Entry inlet plumbing, refer to Step 5 and install the back entry inlet valve.

Now secure the cistern to the pan using the two **bolts with seals** in the cistern/pan attachment holes.

Flush the lines and connect the water supply and check the operation of the cistern.

8 FITTING THE CISTERN LID

Fit the **flush button** into the cistern lid, with the half flush on the left and full flush on the right. Ensure that the rubber feet of the flush button connect and line up correctly with the flush valve inside the cistern.

Fit the **cistern lid** and push the buttons to check operation.

9 OPERATION AND MAINTENANCE

Press the left side half flush to save water and the full flush as required.

Clean the toilet with liquid detergent and a damp cloth.

Do not place water additives inside the cistern as this may have chemicals that damage the valves and impair the functionality of the cistern.

10 SEAT PACKAGE CONTENTS AND INSTALLATION

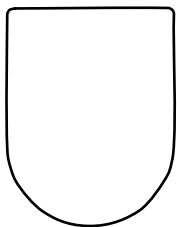

1 x seat and lid
Has receptor holes that slide onto stainless steel pins.

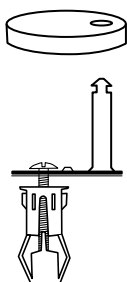

2 x stainless steel caps (used to cover stainless steel plate w pin)
2 x stainless steel plates with pin (seat locates onto stainless steel pins)
2 x toggle bolts (used for securing stainless steel plate and pin to pan)

Secure the toggle bolts into the seat connection holes, ensuring that the stainless steel pins line up with the receptor holes in the seat. Once correctly placed, ensure that the bolts are properly tightened.

Slide the stainless steel caps onto the plates with pins.

To fit the seat, slide it onto the stainless steel pins. You may need to make adjustments to position the seat correctly.

To release the seat, put the seat in an upright position, press the buttons on the seat and lift upwards.

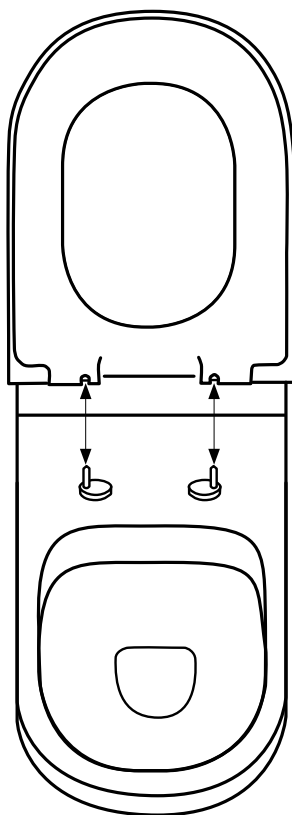

To fit seat, slide seat down onto stainless steel pins.

To remove seat, put seat in upright position, press the buttons on the seat and lift upwards.